

A1

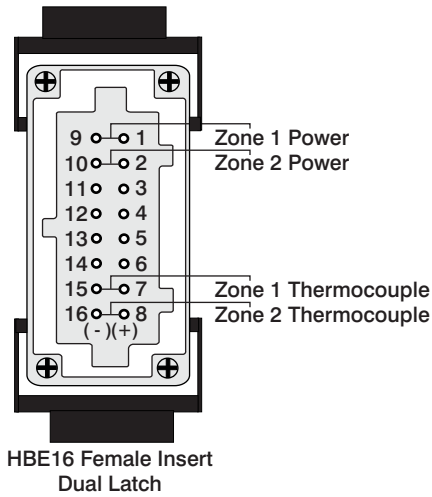

A3

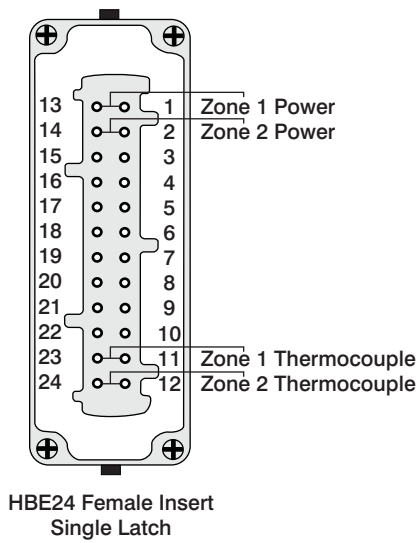

A2

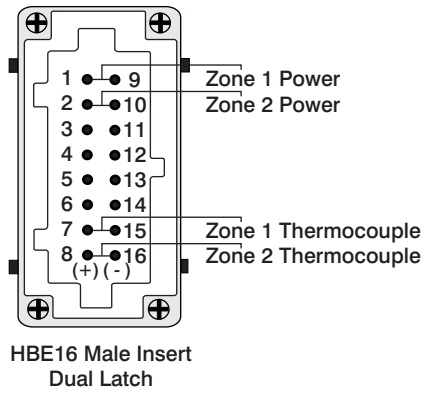

A4

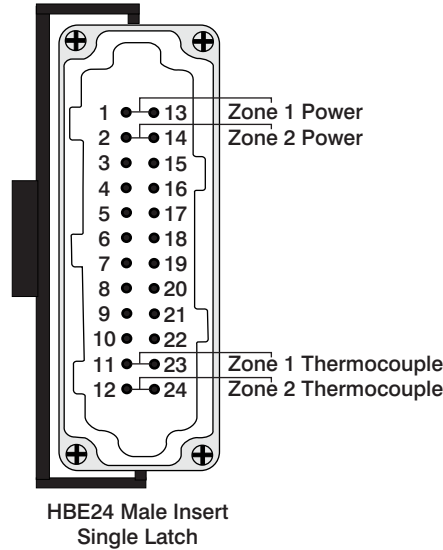

DWG 71

Date: 8.16.2005
 Enclosure: Standard HBE16 - Dual Latch
 Tool End: HBE24 - Single Latch - T/C & Power

Gammflux
 Sterling, VA USA Tel. +1-(703) 471-5050
 Wiesbaden, Germany Tel. +49-(0)-611-973430
 Ube, Japan Tel. +81-(836) 54-4369
 www.gammflux.com; www.gammflux.de

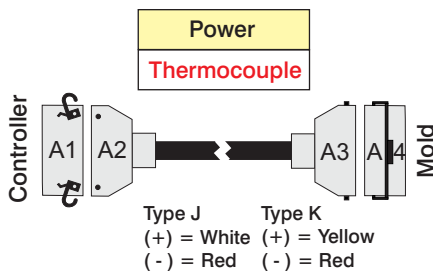

Item	Part Number(s)			Strain Relief
	Base	Hood	Insert	
A1	6124-061		6124-006	
A2		6124-053		6124-038
A3		6124-048	6124-008	6124-038
A4	6124-016		6124-007	
Power & T/C Cable	WAE16E24SC?F??			