

### A1

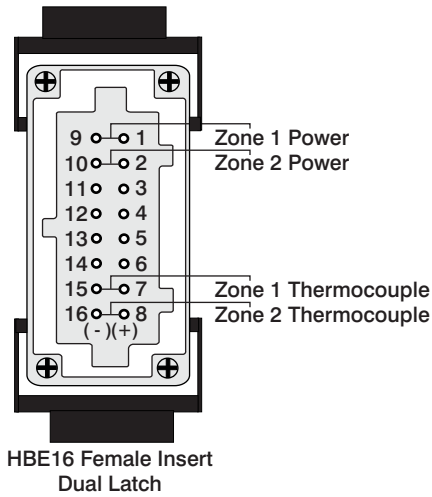

### B1

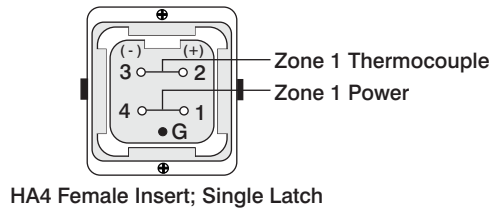
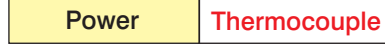

### B2

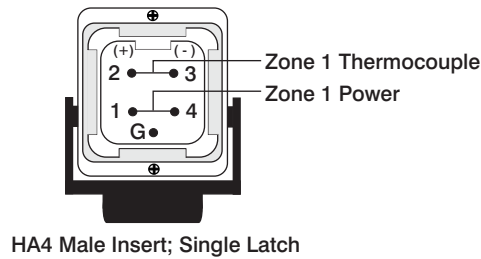

### A2

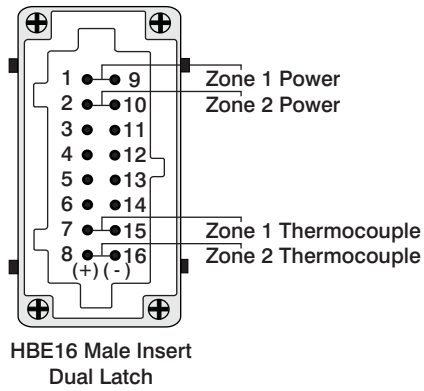

### C1

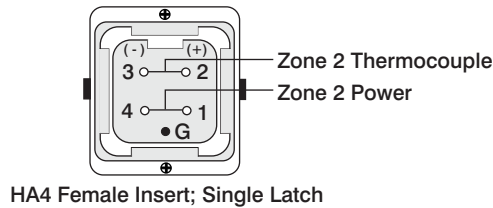

### C2

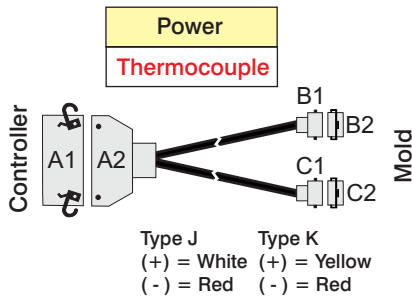
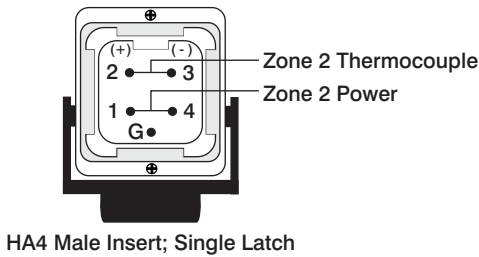

DWG 25

Date: 8.24.2004  
Enclosure: Standard HBE16 - Dual Latch  
Tool End: HA4 - Single Latch - T/C & Power  
HA4 - Single Latch - T/C & Power



Sterling, VA USA Tel. +1-(703) 471-5050  
Wiesbaden, Germany Tel. +49-(0)-611-973430  
Ube, Japan Tel. +81-(836) 54-4369  
www.gammaflux.com; www.gammaflux.de

Item	Part Number(s)			
	Base	Hood	Insert	Strain Relief
A1	6124-061		6124-006	
A2		6124-078	6124-005	6124-052
B1		6124-073	6124-075	6124-076
B2	6124-072		6124-074	
C1		6124-073	6124-075	6124-076
C2	6124-072		6124-074	
Power & T/C Cable	WAE16A11SC???			